

	PART No.	DESCRIPTION	SPECIFICATION
	WSP-2718-D2S1P 120/277VAC Surface Mount w. Dimming Option	<ul style="list-style-type: none"> A Satellite Panel with a WSP-2718-D Dimming Card can control any type of dimming ballasts use the 0-10VDC control method. 	Power (to Satellite Panel) <ul style="list-style-type: none"> 24VAC 50mA.
	WSP-2718-D2F1P 120/277VAC Flush Mount w. Dimming Option	<ul style="list-style-type: none"> There are 8 dimming ballast outputs available. Each can be dimmed to a unique level and is independent of the other outputs. 	Data Signal (to Satellite Panel) <ul style="list-style-type: none"> Standard LonTalk transceiver, FTT-10 (78kbs) type.
	WSP-2718-D3S1P 120/347VAC Surface Mount w. Dimming Option	<ul style="list-style-type: none"> Up to 50 ballasts can be connected to an output. 	Photo Inputs (to Satellite Panel) <ul style="list-style-type: none"> 2 photo sensor connections compatible with Douglas WPS-5527K (outdoor) and WPS-5533K (indoor) modules.
	WSP-2718-D3F1P 120/347VAC Flush Mount w. Dimming Option	<ul style="list-style-type: none"> The WSP-2718-D controls the ballasts in response to light levels measured by a Douglas WPS-5527K outdoor photo sensor or WNP-5533K indoor photo sensor (connected to the Satellite Panel). The WSP-2718-D maintains optimum light levels by responding to incoming light (Open Loop) or ambient light (Closed Loop). The WSP-2718-D can also be programmed to maintain light levels by switching relays ON/OFF at designated setpoints or times. 	Outputs (to WSP-2718D Card) <ul style="list-style-type: none"> 8 outputs suitable for dimming ballasts that use the 0-10VDC control method. A maximum of 50 ballasts can be connected to an output. Connections are polarity sensitive. If a ballast channel is malfunctioning, check the polarity of <u>all</u> ballasts connected. Programming <ul style="list-style-type: none"> The WSP-2718-D is programmed via the WNP-2150 Network Manager. Photo sensor setting levels and the output ballasts response to them are set using the WNP-2150 software interface. The WNP-2150-D utilizes an internal web server, so the connecting PC requires no software other than an internet browser to view or edit the photo settings. The WSP-2718-D can also be programmed using the configuration tools of an external LonWorks control system.

Satellite Panel with WSP-2718-D Dimming Card

Switching Outputs

Eight Switching Relays

Latching relays, lighting load rated. Rating: 20A 120/277/347 VAC. Manual override lever Included.

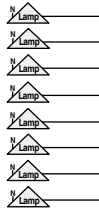

Data Signal

As part of the W-2000 System, the Satellite Panels uses a 2-conductor LonWorks data signal for network-wide communication and control.



Dimming Card

The Dimming Card, which mounts inside the Satellite Panel, has connections for up to 8 separate channels of dimming ballasts.

Each ballast channel will respond, as programmed, to light levels measured by a daylight sensor input.

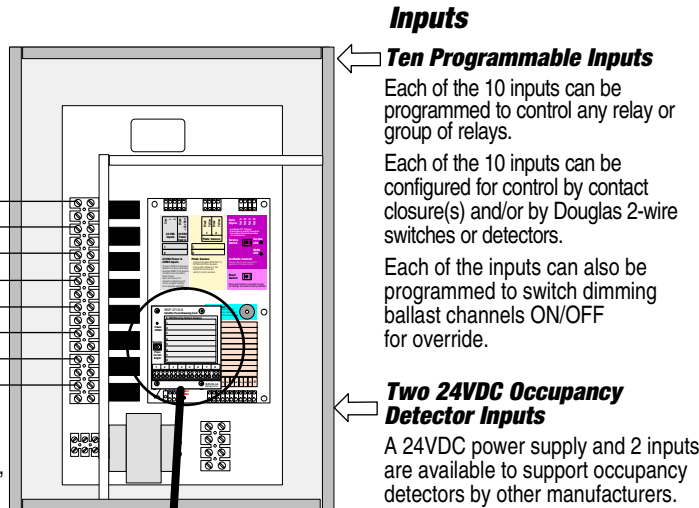
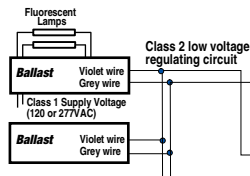

Inputs

Ten Programmable Inputs

Each of the 10 inputs can be programmed to control any relay or group of relays.

Each of the 10 inputs can be configured for control by contact closure(s) and/or by Douglas 2-wire switches or detectors.

Each of the inputs can also be programmed to switch dimming ballast channels ON/OFF for override.

Two 24VDC Occupancy Detector Inputs

A 24VDC power supply and 2 inputs are available to support occupancy detectors by other manufacturers.

Two Douglas Daylight Sensor Inputs

Each daylight sensor input can be programmed to control any relay or group of relays for ON/OFF control or control any of the dimming ballast channels for dimming control.

Daylight sensor can be a Douglas WPS-5533K Indoor Daylight Sensor or a Douglas WPS-5527K Outdoor Daylight Sensor. The WPS-5533K provides Open Loop dimming control where dimming levels are adjusted in response to the incoming light that it measures. The WPS-5577K provides Closed Loop dimming control where dimming levels are adjusted in response to the ambient light that it measures.

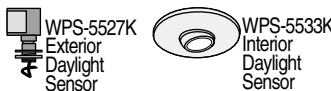

Environment

- Indoors, stationary, non-vibrating, non-corrosive atmosphere and non-condensing humidity.
- Ambient operating temperature: -0°F to +120°F (-15°C to +50°C)

DIMENSIONS & MOUNTING

The WSP-2718-D Card mounts to the Satellite Panel board with the 4 screws and 1" mounting sleeves provided.

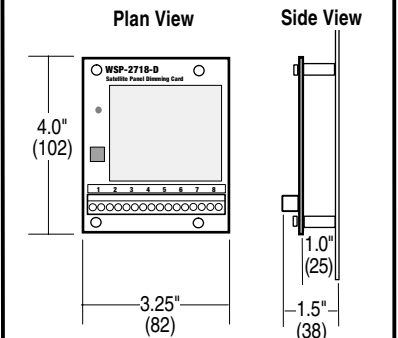

DIMMING CONNECTIONS & APPLICATION: EXAMPLE

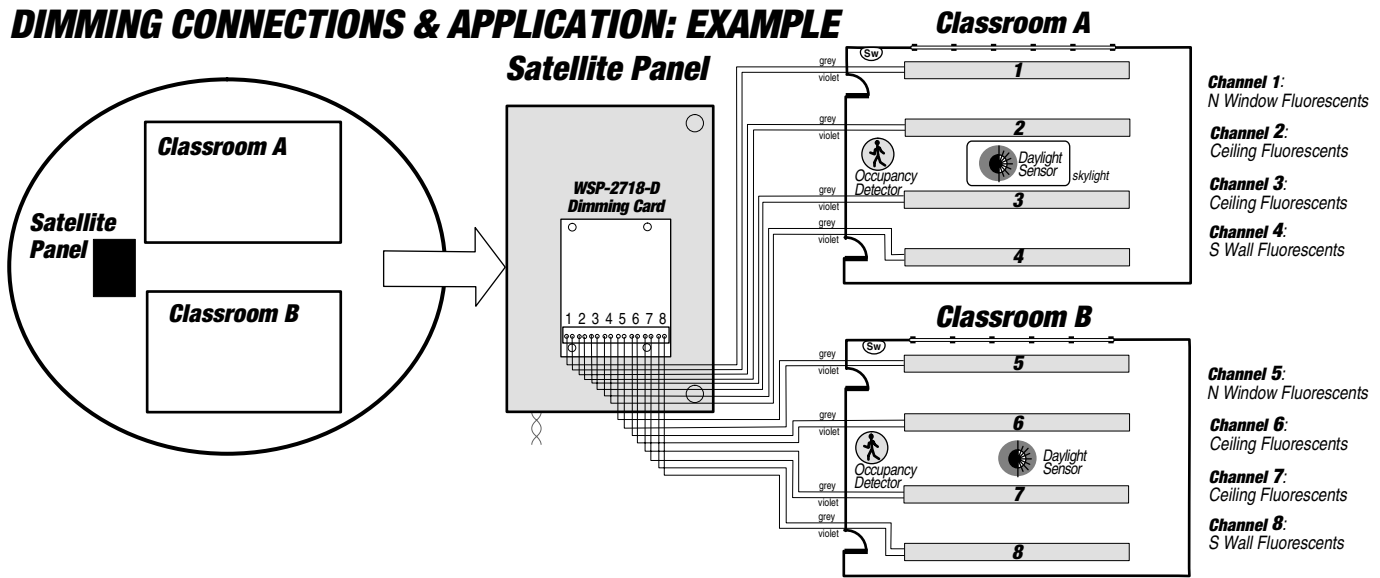

Satellite Panels with Dimming
Install near the loads they control.

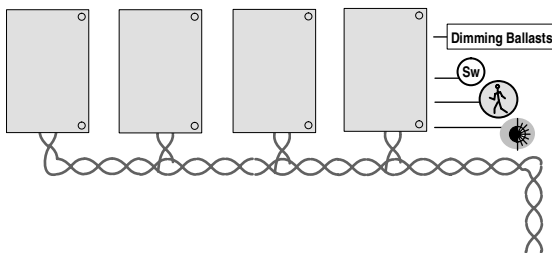

Full-Size Douglas Panels
Capacity 12-72 loads each. Install by breaker panels.

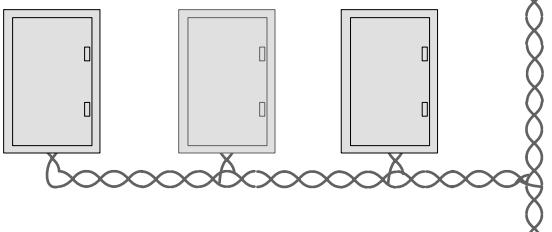

WNP-2150 Network Manager
Internet browser access for system view/edit functions.

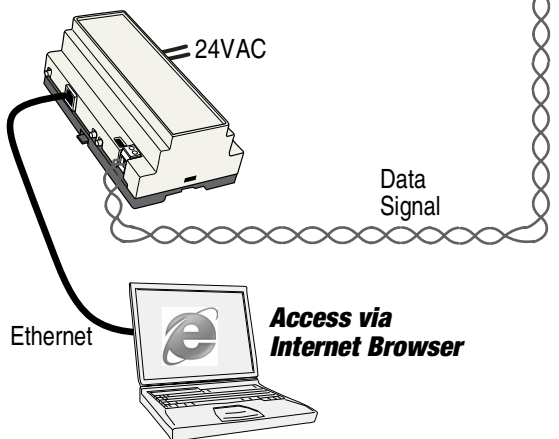

Installation -as per above example

- Install the Satellite Panel near the loads to be controlled. Bring branch circuit(s) to the Satellite Panel as required.
- Connect switches and sensors as needed to the input connections within the Satellite Panel (connections not shown in schematic above). Classroom A has an outdoor daylight sensor mounted at the skylight to measure incoming light. Classroom B has an indoor daylight sensor mounted in the ceiling to measure ambient light. Both classrooms also have an override wall switch and an occupancy sensor.
- Connect the dimming ballasts to the Satellite Panel Dimming Card. For each channel, the violet and grey wires of all the ballasts are connected in parallel to the 'violet' and 'grey' terminals on the card.
- Connect the data signal to Satellite Panel.

Operation

- The Satellite Panel has 2 built-in CLC's ('Constant Lighting Controller') which can switch or dim multiple channels or outputs in response to lighting levels measured by a photo sensor attached to the Satellite Panel.
- The four dimming ballast channels in Classroom A are regulated by the Satellite Panel's CLC A. It is set to *Open Loop* control, which means it constantly adjusts the dimming levels of each channel in response to incoming daylight levels. The incoming daylight is measured by the photo sensor that is mounted at the skylight to Classroom A.
- The four dimming ballast channels in Classroom B are regulated by the Satellite Panel's CLC B. It is set to *Closed Loop* control, which means it constantly adjusts the dimming levels of each channel in response to the reflected light level inside the room. The interior light level is measured by the photo sensor that is mounted in the ceiling of Classroom B.
- The CLC's can be scheduled to operate only during class hours and be OFF (totally dimmed) all other times.
- Switching functions can be linked to the dimming circuits. Each classroom has a wall switch that allows the circuits to be turned ON or OFF when a person enters or leaves the room. Each classroom also has an occupancy sensor that can disable the dimming circuits when the room is unoccupied.

W-2000 System

- The Satellite Panel is part of the W-2000 System. Use the WNP-2150 Network Manager to configure the Satellite panel. Up to 60 network devices can be controlled by a WNP-2150. A Satellite Panel counts as ONE network device.